

# BSB Series Industrial Unmanaged Ethernet Switch with 10/100Base-T(x) Ports and/or BPL (Broadband Power Line Link) and/or SFP Uplink Ports and/or PoE+ Ports User Manual

## 1. About BSB Series Industrial Unmanaged Ethernet Switch



BSB Series Industrial Unmanaged Ethernet Switches are designed for industrial-grade Ethernet, and particularly for facilities of rugged industry and infrastructure. BSB Series Industrial Unmanaged Ethernet Switches are tailored to perform various features, such as wide temperature, wide range power input range... etc. Thus, BSB Series Industrial Unmanaged Ethernet Switches are the best choice for facility management, sewage treatment, power utility, telecommunication, transportation and all other applications that require reliable Ethernet connectivity.

BSB Series has models also with REDZ Broadband Power Line (BPL) communication. BPL link allows device to communicate with full transparent TCP/IP standard over Low Voltage power lines and allows easy connection between TCP/IP based terminals without use of extra cables.

BSB Series has models also with SFP ports for Fiber connectivity. BSB Series with SFP ports offers fiber and ethernet connectivity in same device with plug and play SFP ports. Wide range of SFP modules are available to be used with BSB series.

BSB Series has models also with PoE+ ports for Power over Ethernet connectivity. BSB Series Industrial Unmanaged Ethernet Switches with PoE+ ports can power up to 36W device on a single port and total combined power supply is 90W. Additional PoE splitter can be used to separate power and data for field devices.

## 2. Hardware Features

BSB Series Industrial Unmanaged Ethernet Switches has the versions with and without BPL (Broadband Power Line) Link and with and without SFP Ports.

### 2.1 Features

- Supports up to 8 x 10/100Base-T(x) ports
- AC or DC wide range power options
- Supports Full/Half-Duplex, auto MDI/MDI-X on each port
- Wide operating temperature range from -25 to 70 °C AC and -40 to 85 °C DC power input versions
- Rugged Metal IP-40 housing design
- DIN-Rail mounting

### 2.2 Extra Features for Models with BPL

- Supports up to 7 x 10/100Base-T(x) ports + 1 x BPL link
- Wide range 3 phase AC input
- Supports up to 30Mbps PHY rate on BPL with Up to 10 hops and 1000 nodes
- Up to 432 sub-carriers from 2 to 28MHz analog bandwidth
- Support LDPC-C FEC with 128-bit AES core
- Plug and play with Master/Slave selection via switch

### 2.3 Features for Models with SFP Ports

- Supports 8 x 10/100Base-T(x) ports

- Supports 2 x 10/100/1000 SFP Ports
- Plug-and-play without additional settings
- AC or DC wide range power options
- Wide operating temperature range from -25 to 70 °C AC and -40 to 85 °C DC power input versions
- Rugged Metal IP-40 housing design
- DIN-Rail mounting

## 2.4 Features for Models with PoE+ Ports

- Supports 8 x 10/100Base-T(X) ports
  - Supports PoE+ on all ports
- 90 Watt Power Supply combined for all ports
- Maximum 36 Watt per port
- IEEE 802.3AF-2003 and 802.3AT-2009 compliant
  - Plug-and-play without additional settings
  - 100 - 240V AC (120 - 370V DC), 50Hz to 60Hz AC wide range power input
- 90Watt Power Supply
- Wide operating temperature range from -30 to 80 °C
  - Rugged Metal IP-40 housing design
  - DIN-Rail mounting

## 3. Installation

Each switch has a Din-Rail kit on rear panel. The Din-Rail kit helps switch to fix on the Din-Rail. Slant the switch and mount the metal spring to Din-Rail.



Then Push the switch toward the Din-Rail until you heard a "click" sound.



## 4. Front Panel Description

### 4.1 BSB115 & BSB215

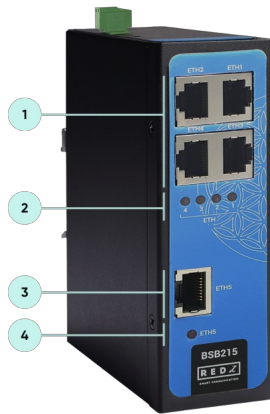

1. 10/100Base-T(X) Ethernet ports 1, 2, 3 and 4.
2. ETHERNET Activity LEDs for port 1, 2, 3 and 4. Blinks during ethernet activity.
3. 10/100Base-T(X) Ethernet port 5.
4. ETHERNET Activity LED for port 5. Blinks during ethernet activity.

### 4.2 BSB118 & BSB218

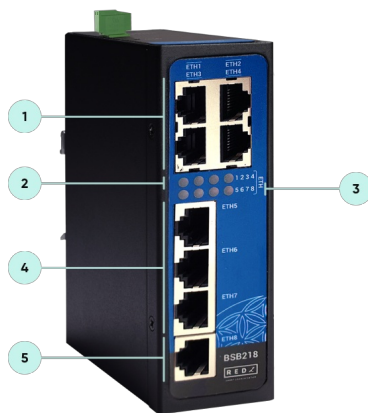

1. 10/100Base-T(X) Ethernet ports 1, 2, 3 and 4.
2. ETHERNET Activity LEDs for port 1, 2, 3 and 4. Blinks during ethernet activity.
3. ETHERNET Activity LEDs for port 5, 6, 7 and 8. Blinks during ethernet activity.
4. 10/100Base-T(X) Ethernet ports 5, 6, 7 and 8.

### 4.3 BSB120&BSB220

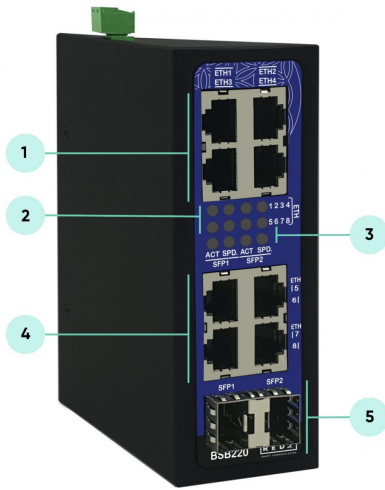

1. 10/100Base-T(X) Ethernet ports 1, 2, 3 and 4.
2. ETHERNET Activity LEDs for port 1, 2, 3, 4, 5, 6, 7 and 8. Blinks during ethernet activity.
3. ETHERNET Activity LEDs for SFP Ports 1 and 2. There are 2 LEDs for each port. One Blinks during ethernet activity and one is steady when speed is Gigabit .
4. 10/100Base-T(X) Ethernet ports 5, 6, 7 and 8.
5. 10/100/1000 SFP Ports 1 and 2.

#### 4.4 BSB268

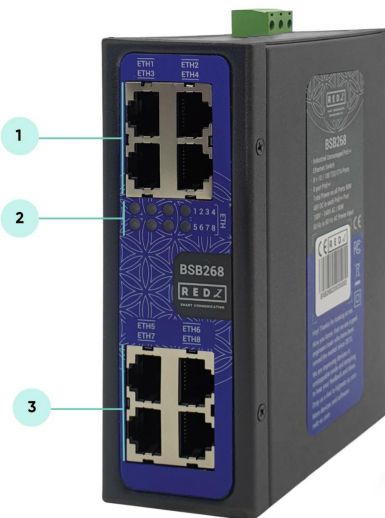

1. 10/100Base-T(X) Ethernet ports 1, 2, 3 and 4.  
Supports PoE+ on all ports  
90 Watt Power Supply combined for all ports  
Maximum 36 Watt per port
2. ETHERNET Activity LEDs for port 1, 2, 3, 4, 5, 6, 7 and 8. Blinks during ethernet activity.
3. 10/100Base-T(X) Ethernet ports 5, 6, 7 and 8.  
Supports PoE+ on all ports  
90 Watt Power Supply combined for all ports  
Maximum 36 Watt per port

#### 4.5 BSB612



1. 10/100Base-T(X) Ethernet port.
2. BPL Activity LED. Blinks during BPL & Ethernet activity.
3. BPL Link LED. LED Turns ON if the link can be established.
4. Master Indication LED. LED Turns ON if the device is started as "Master" device.
5. Switch position to select the device as "Master" or "Slave". Device must be repowered after changing the setting to take into effect.

#### 4.6 BSB615



1. 10/100Base-T(X) Ethernet ports 1, 2, 3 and 4.
2. ETHERNET Activity LEDs for port 1, 2, 3 and 4. Blinks during ethernet activity.
3. BPL Activity LED. Blinks during BPL & Ethernet activity.
4. BPL Link LED. LED Turns ON if the link can be established.
5. Master Indication LED. LED Turns ON if the device is started as "Master" device.
6. Switch position to select the device as "Master" or "Slave". Device must be repowered after changing the setting to take into effect.

#### 4.7 BSB618

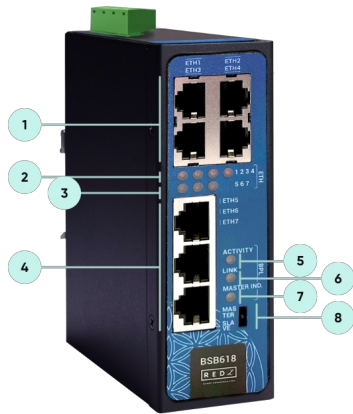

1. 10/100Base-T(X) Ethernet ports 1, 2, 3 and 4.
2. ETHERNET Activity LEDs for port 1, 2, 3 and 4. Blinks during ethernet activity.
3. ETHERNET Activity LEDs for port 5, 6, and 7. Blinks during ethernet activity.
4. 10/100Base-T(X) Ethernet ports 5, 6, and 7.
5. BPL Activity LED. Blinks during BPL & Ethernet activity.
6. BPL Link LED. LED Turns ON if the link can be established.
7. Master Indication LED. LED Turns ON if the device is started as "Master" device.
8. Switch position to select the device as "Master" or "Slave". Device must be repowered after changing the setting to take into effect.

## 5. Top Panel Description

### 5.1 BSB115 & BSB118 & BSB120

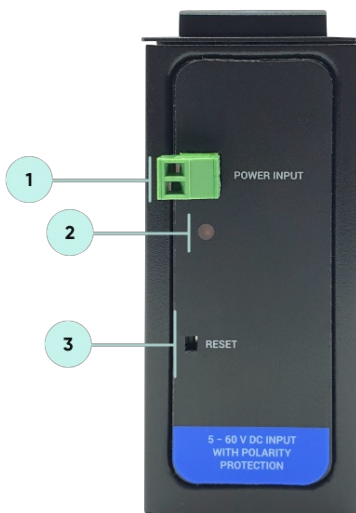

1. Power Input DC: 5-60V DC. Polarity protected so that the power input can be connected in any direction.
2. Power LED: Turns ON when there is power in device.
3. Reset Button: Reset the device.

## 5.2 BSB215 & BSB218 & BSB220

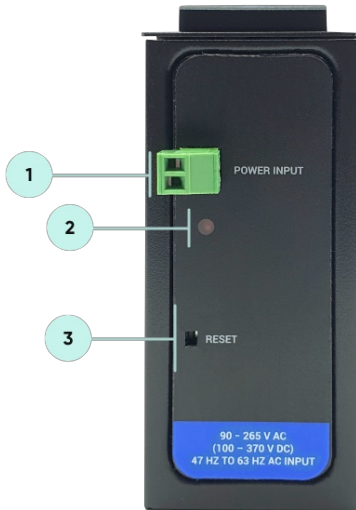

1. Power Input AC: 90 - 265V AC (100 - 370V DC), 47Hz to 63Hz AC input.
2. Power LED: Turns ON when there is power in device.
3. Reset Button: Reset the device.

## 5.3 BSB268

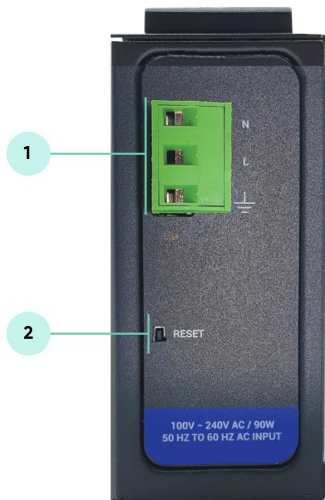

1. Power Input AC: 100 - 240V AC (120 - 370V DC), 50Hz to 60Hz AC Wide Range Power Input  
90Watt Power Supply
2. Reset Button: Reset the device.

## 5.4 BSB612 & BSB615 & BSB618

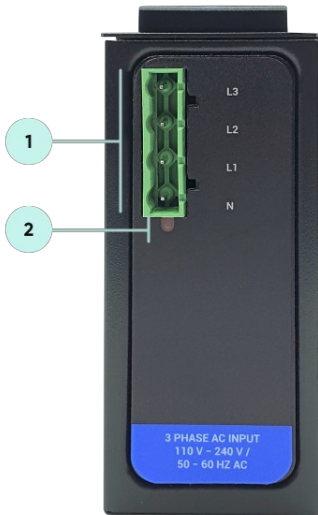

1. Power Input AC: 3 phase input, 110V–240V/50–60Hz. It is also ok to connect only single phase to the device such as L1-N connection only.

AC Power supply use L1-N only. Phase 2-3 connections are used to BPL signal transmission.

2. Power LED: Turns ON when there is power in device.



**NOTE1 :** BPL Model can be purchased in 2 versions:

1. P-N Model: Phase to neutral model (Standart Model). That version gets power from terminal pins 1 and 2 from phase and neutral. It can also transmit data from that pins and other pins usage is optional (Ex: Master can be connected to all phases and slaves can be connected to relevant phases)

2. P-P Model: Phase to phase model. That version also gets power from terminal pins 1 and 2 from phase and neutral. Data transmission only done through terminal pins 3 and 4. Phase to phase connection can be done to data transmission pins for better performance.

If not used then phase and neutral can still be connected for data transmission for terminal pins 3 and 4.



**NOTE2:** BPL Model can be purchased in DC model as well:

This model will be same as "P-P Model"( Phase to phase model) on data connection and gets **12V DC power** from terminal pins 1 and 2. Data transmission only done through terminal pins 3 and 4.

## 6. Ethernet Cables, SFP Module Options

BSB Series Industrial Unmanaged Ethernet Switches have standard Ethernet ports. According to the link type, the switches use CAT 3, 4, 5, 5e UTP cables to connect to any other network device (PCs, servers, switches, routers, or hubs).

### 6.1 Cable Type and Specifications

Cable	Type	Max. Length	Connector
10BASE-T	Cat. 3, 4, 5 100-ohm	UTP 100 m (328 ft)	RJ-45
100BASE-TX	Cat. 5 100-ohm UTP	UTP 100 m (328 ft)	RJ-45

### 6.2 ETH Cable Pin Assignments



With 100BASE-TX/10BASE-T cable, pins 1 - 2 are used for transmitting data and pins 3 - 6 are used for receiving data.

Pin Number	Description
1	TD+
2	TD-
3	RD+
4	Not Used
5	Not Used
6	RD-
7	Not Used
8	Not Used

### 6.3 SFP Module Options

Following SFP modules are available to be used with BSB SFP versions

Model Name	Description	SFP Type	Technical Details	Explanation	How to Use	Cables Used
CE-GLC-FE-100FX	155M, Dual Fiber, Multi Mode, 1310nm, 2KM, Industrial	100Mbit/s SFP	F2 Multi-mode fiber; LC connector; with black or Beige color coding	LFX (name dependent on manufacturer) – 1310 nm, for a distance up to 2 km	Connect 2 x same device on both device	LC-LC MM Duplex
CE-GLC-FE-100LX	155M, Dual Fiber, SM, 1310nm, 20KM, Industrial	100Mbit/s SFP	Single-mode fiber, LC connector, with blue color coding	LX – 1310 nm, for distances up to 20 km	Connect 2 x same device on both device	LC-LC SM Duplex
GLC-BX-20U	155M Bidi SFP, 1310nm-TX/1550nm-RX, 20km, LC Port, Industrial	100Mbit/s SFP	Single-mode fiber, LC connector, Bi-Directional, with blue and yellow color coding	BX (officially BX10) – 1550 nm/1310 nm, Single Fiber Bi-Directional 100 Mbit SFP Transceivers, paired as BX-U (blue) and BX-D (yellow) for uplink and downlink respectively, also for distances up to 20 km. Variations of bidirectional SFPs are also manufactured which higher transmit power versions with link length capabilities up to 20 km.	Connect 1 x U version on 1 device and 1 x D version on other device	LC-LC SM Simplex
GLC-BX-20D	155M Bidi SFP, 1550nm-TX/1310nm-RX, 20km, LC Port, Industrial	100Mbit/s SFP				
CE-GLC-T	10/100M Copper SFP, RJ45 Port, 100M, Industrial	100Mbit/s SFP	Copper twisted-pair cabling, 8P8C (RJ-45) connector	100BASE-TX – for distances up to 100m.	Connect 2 x same device on both device	RJ45 Cable
GLC-SX-MMD	1.25G, Dual Fiber, MM, 850nm, 550m, Industrial	1Gbit/s SFP	1 Gbit/s multi-mode fiber, LC connector, with black or beige extraction lever	SX – 850 nm, for a maximum of 550 m at 1.25 Gbit/s (gigabit Ethernet). Other multi-mode SFP applications support even higher rates at shorter distances.	Connect 2 x same device on both device	LC-LC MM Duplex
CE-GLC-BX-3U	1.25G Bidi SFP, 1310nm-TX/1550nm-RX, 3km, SC or LC Port, Industrial	1Gbit/s SFP	1 to 2.5 Gbit/s single-mode fiber, LC connector, with blue extraction lever	BX (officially BX10) – 1550 nm/1310 nm, Single Fiber Bi-Directional Gigabit SFP Transceivers, paired as BX-U and BX-D for uplink and downlink respectively, also for distances up to 10 km. Variations of bidirectional SFPs are also manufactured which use 1550 nm in one direction, and higher transmit power versions with link length	Connect 1 x U version on 1 device and 1 x D version on other device	LC-LC SM Simplex
CE-GLC-BX-3D	1.25G Bidi SFP, 1550nm-TX/1310nm-RX, 3km, SC or LC Port, Industrial	1Gbit/s SFP				
CE-GLC-BX-10U	1.25G Bidi SFP, 1550nm-TX/1310nm-RX, 10km, LC or SC Port, Industrial	1Gbit/s SFP				
CE-GLC-BX-10D	1.25G Bidi SFP, 1550nm-TX/1310nm-RX, 10km, LC or SC Port, Industrial	1Gbit/s SFP				
CE-GLC-BX-20U	1.25G Bidi SFP, 1310nm-TX/1550nm-RX, 20km, LC or SC Port, Industrial	1Gbit/s SFP				
CE-GLC-BX-20D	1.25G Bidi SFP, 1550nm-TX/1310nm-RX, 20km, LC or SC Port, Industrial	1Gbit/s SFP				

CE-GLC-BX-40U	1.25G Bidi SFP, 1310nm-TX/1550nm-RX, 40km, LC or SC Port, Industrial	1Gbit/s SFP		capabilities up to 80 km.		
CE-GLC-BX-40D	1.25G Bidi SFP, 1550nm-TX/1310nm-RX, 40km, LC or SC Port, Industrial	1Gbit/s SFP				
CE-GLC-T	10/100/1000M Copper SFP, RJ45 Port, 100M, Industrial	1Gbit/s SFP	1 Gbit/s for copper twisted-pair cabling, 8P8C (RJ-45) connector	1000BASE-T – these modules incorporate significant interface circuitry for Physical Coding Sublayer recoding and can be used only for gigabit Ethernet because of the specific line code. They are not compatible with (or rather: do not have equivalents for) Fiber Channel. Unlike non-SFP, copper 1000BASE-T ports integrated into most routers and switches, 1000BASE-T SFPs usually cannot operate at 100BASE-TX speeds.	Connect 2 x same device on both device	RJ45 Cable
GLC-LH-SMD	1.25G, Dual Fiber, 1310nm, 10km, Industrial	1Gbit/s SFP	Single Mode fiber, LC connector	LH – 1310 nm, for a maximum of 10KM at 1.25 Gbit/s (gigabit Ethernet). Other multi-mode SFP applications support even higher rates at shorter distances.	Connect 2 x same device on both device	LC-LC SM Duplex
GLC-LH-SMD-20	1.25G, Dual Fiber, 1310nm, 20km, Industrial	1Gbit/s SFP	Single Mode fiber, LC connector	LH – 1310 nm, for a maximum of 10KM at 1.25 Gbit/s (gigabit Ethernet). Other multi-mode SFP applications support even higher rates at shorter distances.	Connect 2 x same device on both device	LC-LC SM Duplex



**NOTE:** Multi Mode Duplex should connect same Multi Mode Duplex wavelength, like 850MM should connector MM 850nm, couldn't connect MM 1310.

Single Mode duplex should connect same Single Mode wavelength, SM Duplex 1310 should connect SM 1310 Duplex, couldn't connect SM Duplex 1550NM.

Duplex couldn't connect Simplex BIDI.

Simplex BIDI only connect simplex BIDI U connect D, D couldn't connect D U couldn't connect U.

Single Mode(SM) couldn't connect Multi Mode(MM).

## 6.4 PoE+ Cable Pin Assignments

Pin Number	Data
Pin 1	Rx +
Pin 2	Rx -
Pin 3	Tx +
Pin 4	Unused
Pin 5	Unused
Pin 6	Tx -
Pin 7	Unused
Pin 8	Unused

## 7. SFP Types

The small form-factor pluggable (SFP) is a compact, hot-pluggable network interface module used for both telecommunication and data communications applications. An SFP interface on networking hardware is a modular slot for a media-specific transceiver in order to connect a fiber-optic cable or sometimes a copper cable.

The advantage of using SFPs compared to fixed interfaces (e.g. modular connectors in Ethernet switches) is that individual ports can be equipped with any suitable type of transceiver as needed.

## 7.1 100Mbit/s SFP

- Multi-mode fiber, LC connector, with black or Beige color coding

SX – 850 nm, for a maximum of 550 m

- Multi-mode fiber, LC connector, with blue color coding

FS – 1300 nm, for a distance up to 5 km.

LFX (name dependent on manufacturer) – 1310 nm, for a distance up to 5 km.

Available SFP module from REDZ:

Model Name	Description	Cable Used
CE-GLC-FE-100FX	155M, Dual Fiber, Multi Mode, 1310nm, 2KM, Industrial	LC-LC MM Duplex

- Single-mode fiber, LC connector, with blue color coding

LX – 1310 nm, for distances up to 20 km

Available SFP module from REDZ:

Model Name	Description	Cable Used
CE-GLC-FE-100LX	155M, Dual Fiber, SM, 1310nm, 20KM, Industrial	LC-LC SM Duplex

EX – 1310 nm, for distances up to 40 km

- Single-mode fiber, LC connector, with green color coding

ZX – 1550 nm, for distances up to 80 km, (depending on fiber path loss)

EZX – 1550 nm, for distances up to 160 km (depending on fiber path loss)

- Single-mode fiber, LC connector, Bi-Directional, with blue and yellow color coding

BX (officially BX10) – 1550 nm/1310 nm, Single Fiber Bi-Directional 100 Mbit SFP Transceivers, paired as BX-U (blue) and BX-D (yellow) for uplink and downlink respectively, also for distances up to 10 km. Variations of bidirectional SFPs are also manufactured which higher transmit power versions with link length capabilities up to 40 km.

Available SFP module from REDZ:

Model Name	Description	Cable Used
GLC-BX-20U	155M Bidi SFP, 1310nm-TX/1550nm-RX, 20km, LC Port, Industrial	LC-LC SM Simplex
GLC-BX-20D	155M Bidi SFP, 1550nm-TX/1310nm-RX, 20km, LC Port, Industrial	LC-LC SM Simplex

- Copper twisted-pair cabling, 8P8C (RJ-45) connector

100BASE-TX – for distances up to 100m.

Available SFP module from REDZ:

Model Name	Description	Cable Used
CE-GLC-T	10/100M Copper SFP, RJ45 Port, 100M, Industrial	RJ45 Cable

## 7.2 1Gbit/s SFP

- 1 Gbit/s multi-mode fiber, LC connector, with black or beige extraction lever

SX – 850 nm, for a maximum of 550 m at 1.25 Gbit/s (gigabit Ethernet). Other multi-mode SFP applications support even higher rates at shorter distances.

Available SFP module from REDZ:

Model Name	Description	Cable Used
GLC-SX-MMD	1.25G, Dual Fiber, MM, 850nm, 550m, Industrial	LC-LC MM Duplex

- 1.25 Gbit/s multi-mode fiber, LC connector, extraction lever colors not standardized

SX+/MX/LSX (name dependent on manufacturer) – 1310 nm, for a distance up to 2 km. Not compatible with SX or 100BASE-FX. Based on LX but engineered to work with a multi-mode fiber using a standard multi-mode patch cable rather than a mode-conditioning cable commonly used to adapt LX to multi-mode.

- 1 to 2.5 Gbit/s single-mode fiber, LC connector, with blue extraction lever

LX – 1310 nm, for distances up to 10 km (originally, LX just covered 5 km and LX10 for 10 km followed later)

LH – 1310 nm, for a maximum of 20 km. Other multi-mode SFP applications support even higher rates at shorter distances.

Model Name	Description	Cable Used
GLC-LH-SMD	1.25G, Dual Fiber, 1310nm, 10km, Industrial	LC-LC SM Duplex
GLC-LH-SMD-20	1.25G, Dual Fiber, 1310nm, 20km, Industrial	LC-LC SM Duplex

EX – 1310 nm, for distances up to 40 km

ZX – 1550 nm, for distances up to 80 km (depending on fiber path loss), with green extraction lever (see GLC-ZX-SM1)

EZX – 1550 nm, for distances up to 160 km (depending on fiber path loss)

BX (officially BX10) – 1490 nm/1310 nm, Single Fiber Bi-Directional Gigabit SFP Transceivers, paired as BX-U and BX-D for uplink and downlink respectively, also for distances up to 10 km. Variations of bidirectional SFPs are also manufactured which use 1550 nm in one direction, and higher transmit power versions with link length capabilities up to 80 km.

Available SFP module from REDZ:

Model Name	Description	Cable Used
CE-GLC-BX-3U	1.25G Bidi SFP, 1310nm-TX/1550nm-RX, 3km, SC or LC Port, Industrial	LC-LC SM Simplex
CE-GLC-BX-3D	1.25G Bidi SFP, 1550nm-TX/1310nm-RX, 3km, SC or LC Port, Industrial	LC-LC SM Simplex
CE-GLC-BX-10U	1.25G Bidi SFP, 1550nm-TX/1310nm-RX, 10km, LC or SC Port, Industrial	LC-LC SM Simplex
CE-GLC-BX-10D	1.25G Bidi SFP, 1550nm-TX/1310nm-RX, 10km, LC or SC Port, Industrial	LC-LC SM Simplex
CE-GLC-BX-20U	1.25G Bidi SFP, 1310nm-TX/1550nm-RX, 20km, LC or SC Port, Industrial	LC-LC SM Simplex
CE-GLC-BX-20D	1.25G Bidi SFP, 1550nm-TX/1310nm-RX, 20km, LC or SC Port, Industrial	LC-LC SM Simplex
CE-GLC-BX-40U	1.25G Bidi SFP, 1310nm-TX/1550nm-RX, 40km, LC or SC Port, Industrial	LC-LC SM Simplex
CE-GLC-BX-40D	1.25G Bidi SFP, 1550nm-TX/1310nm-RX, 40km, LC or SC Port, Industrial	LC-LC SM Simplex

1550 nm 40 km (XD), 80 km (ZX), 120 km (EX or EZX)

SFSW – single-fiber single-wavelength transceivers, for bi-directional traffic on a single fiber. Coupled with CWDM, these double the traffic density of fiber links.

Coarse wavelength-division multiplexing (CWDM) and dense wavelength-division multiplexing (DWDM) transceivers at various wavelengths achieving various maximum distances. CWDM and DWDM transceivers usually support link distances of 40 km, 80 km and 120 km.

- 1 Gbit/s for copper twisted-pair cabling, 8P8C (RJ-45) connector

1000BASE-T – these modules incorporate significant interface circuitry for Physical Coding Sublayer recoding and can be used only for gigabit Ethernet because of the specific line code. They are not compatible with (or rather: do not have equivalents for) Fiber Channel. Unlike non-SFP, copper 1000BASE-T ports integrated into most routers and switches, 1000BASE-T SFPs usually cannot operate at 100BASE-TX speeds.

Available SFP module from REDZ:

Model Name	Description	Cable Used
CE-GLC-T	10/100/1000M Copper SFP, RJ45 Port, 100M, Industrial	RJ45 Cable

## 8. Connection Diagrams

BSB Series Industrial Unmanaged Ethernet Switches connections vary based on with and without BPL (Broadband Power Line ) Link versions.

### 8.1 Connection Diagram for BPL Versions

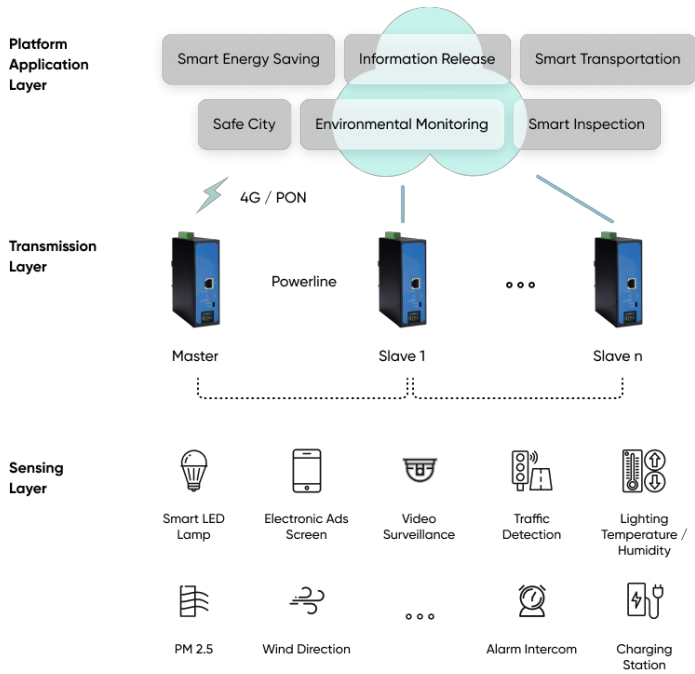

### 8.2 Connection Diagram for ETH Versions



### 8.3 Connection Diagram for SFP Port Versions

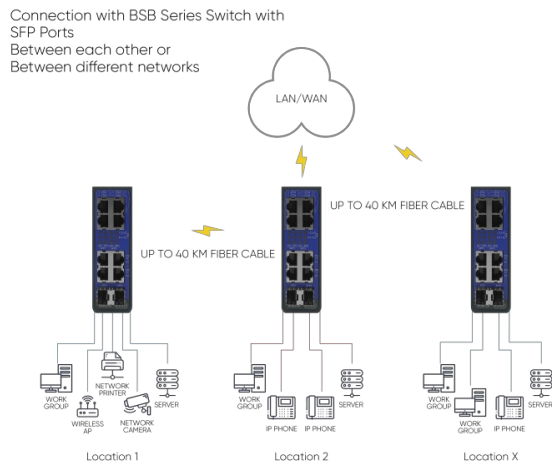

### 8.4 Connection Diagram for PoE+ Versions

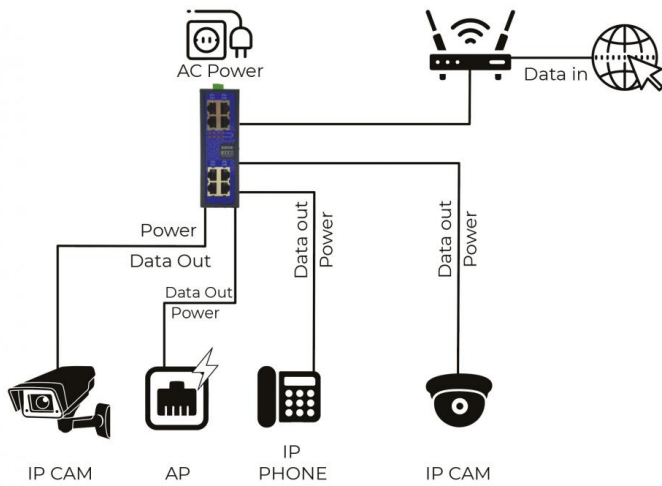

## 9. System Comparison Between CAT5 and BPL Links

	CAT5 Based System	BPL Link Based System
Media	CAT5	Power Line
Bandwidth	100Mbps	Up to 30Mbps
Re-Wire	Yes	No, Using existing Power Line
Span	<100m	<600m
Multiple Nodes	N/A	Up to 10 hops/1000 nodes
Encryption	Yes, but difficult to configure	Yes, Plug & Play
Installment	Difficult	Easy, simply user power line
Installment Cost	High	Low
Total Cost	High	Low



**NOTE1:** BPL Model can be purchased in 2 versions:

1. P-N Model: Phase to neutral model (Standart Model). That version gets power from terminal pins 1 and 2 from phase and neutral. It can also transmit data from that pins and other pins usage is optional (Ex: Master can be connected to all phases and slaves can be connected to relevant phases)
2. P-P Model: Phase to phase model. That version also gets power from terminal pins 1 and 2 from phase and neutral. Data transmission only done through terminal pins 3 and 4. Phase to phase connection can be done to data transmission pins for better performance. If not used then phase and neutral can still be connected for data transmission for terminal pins 3 and 4.



**NOTE2:** BPL Model can be purchased in DC model as well:

This model will be same as "P-P Model"( Phase to phase model) on data connection and gets 12V DC power from terminal pins 1 and 2. Data transmission only done through terminal pins 3 and 4.

## 10. Broadband Power Line (BPL) Communication - Video Examples

### 10.1 Firmware Update Video Example for Broadband Power Line (BPL) BSB Models

Default firmware for Broadband Power Line (BPL) version BSB series shipped with multi hop (mesh network) functionality. If needed that firmware can be changed in the field.



**NOTE:** Devices can be order with desired functionality during order. It is not advised to change firmware in field unless it is a must, since mistakes during that procedure may make device unreachable.

Here are steps to achieve that:

1. Set your PC's IP for Software Tool.
2. To control the connection, set 4 BPL products, 1 of which is "Master" and 3 of which are "Slave", from the switch on the BSB series.  
Then search devices in Software Tool.
3. You should see all connected BPL products in the Software Tool search result. On the Software Tool screen, under the heading "Active SDK"; if it says "4.xx...", the installed firmware is "MultiHop", if it says "2.xx....", the firmware is "NoHop".
4. Mark the module those firmware you want to change, first load the "ROM" file with "Firm. UP", then the "sys" file with "Sys Area".
5. After the updates, restart the system and search again with Software Tool. That means process has been finished successfully.

Here is a video for application:



**NOTE1:** BPL Model can be purchased in 2 versions:

1. P-N Model: Phase to neutral model (Standard Model). That version gets power from terminal pins 1 and 2 from phase and neutral. It can also transmit data from that pins and other pins usage is optional (Ex: Master can be connected to all phases and slaves can be connected to relevant phases)
2. P-P Model: Phase to phase model. That version also gets power from terminal pins 1 and 2 from phase and neutral. Data transmission only done through terminal pins 3 and 4. Phase to phase connection can be done to data transmission pins for better performance.  
If not used then phase and neutral can still be connected for data transmission for terminal pins 3 and 4.



**NOTE2:** BPL Model can be purchased in DC model as well:

This model will be same as "P-P Model" (Phase to phase model) on data connection and gets **12V DC power** from terminal pins 1 and 2. Data transmission only done through terminal pins 3 and 4.

## 10.2 Communication Video Example for No Hop version of Broadband Power Line (BPL) BSB Models which are Paired in Same Power Network

BSB series BPL switches can work without hops. This is tree based communication and there will be 1 master and many slaves and all slaves will be connected to master directly (without hops).



**NOTE:** No hop version needs special firmware and user can get that firmware from our company and update devices in field.

There is also another option for no hop firmware, devices can be paired so that there can be many masters and many slaves in same power network. This can help to isolate BPL connections from each other.

Here are steps to achieve that:

1. Set your PC's IP for Software Tool.
2. To control the connection, set 4 BPL products, 1 of which is "Master" and 3 of which are "Slave", from the switch on the BSB series.  
Then search devices in Software Tool.
3. You can group devices by assigning a Domain Number from the Domain Management menu. After assigning the Domain to the first group, set the other group as 1 Master 1 Slave from switches, restart devices, plug the eth cable into this group and repeat the process.
4. After grouping, restart the system.
5. When you search on Software Tool, this time you should see 2 BPL products, not 4.

You should see the details of the group to which the eth cable is plugged. That means process has been finished successfully.

Here is a video for application:

Here is a video for physical application:

Here is a video for speed test:

### 10.3 Communication Video Example for DC powered version of Broadband Power Line (BPL) BSB Models

Here is an example communication video for BSB615 DC powered models

Here is an example communication video for BSB618 DC powered models

## 11. Ordering Information

**BSB115:** Industrial Unmanaged Ethernet Switch, 5 x 10/100 T(x) ETH ports, 5- 48 (max. 60V) DC Power Input

**BSB118:** Industrial Unmanaged Ethernet Switch, 8 x 10/100 T(x) ETH ports, 5- 48 (max. 60V) DC Power Input

**BSB120:** Industrial Unmanaged Ethernet Switch, 8 x 10/100 T(x) ETH ports and 2 x SFP Uplink Ports, 5- 48 (max. 60V) DC Power Input

**BSB215:** Industrial Unmanaged Ethernet Switch, 5 x 10/100 T(x) ETH ports, 100 - 240V AC (120 - 370V DC), 50Hz to 60Hz AC Power Input

**BSB218:** Industrial Unmanaged Ethernet Switch, 8 x 10/100 T(x) ETH ports, 100 - 240V AC (120 - 370V DC), 50Hz to 60Hz AC Power Input

**BSB220:** Industrial Unmanaged Ethernet Switch, 8 x 10/100 T(x) ETH ports and 2 x SFP Uplink Ports, 100 - 240V AC (120 - 370V DC), 50Hz to 60Hz AC Power Input

**BSB268:** Industrial Unmanaged PoE+ Ethernet Switch, 8 x 10/100 T(x) ETH ports and all Ports Support PoE+, 100 - 240V AC (120 - 370V DC), 50Hz to 60Hz AC Wide Range Power Input, 90 Watt Power Supply combined for all ports

**BSB612:** Industrial Unmanaged Ethernet Switch, 1 x 10/100 T(x) ETH ports + 1 x BPL (Broadband Power Line) Link, 3 Phase AC Power Input, 110V-240V/50-60Hz

**BSB615:** Industrial Unmanaged Ethernet Switch, 4 x 10/100 T(x) ETH ports + 1 x BPL (Broadband Power Line) Link, 3 Phase AC Power Input, 110V-240V/50-60Hz

**BSB618:** Industrial Unmanaged Ethernet Switch, 7 x 10/100 T(x) ETH ports + 1 x BPL (Broadband Power Line) Link, 3 Phase AC Power Input, 110V-240V/50-60Hz

## 12. Product Selection

Model	5-48V (Max.60V) DC Power input	100 - 240V AC (120 - 370V DC), 50Hz to 60Hz AC Power Input	3 Phase AC Power input, 110V-240V/50-60Hz AC Power Input	8 x 10/100 T(x) ETH Ports	7 x 10/100 T(x) ETH Ports	5 x 10/100 T(x) ETH Ports	4 x 10/100 T(x) ETH Ports	1 x 10/100 T(x) ETH Ports	BPL (Broadband Power Line) Link	2 x SFP Uplink Ports	PoE+, 90 Watt Power Supply combined for all ports
BSB115	X					X					
BSB118	X			X							
BSB120	X			X						X	
BSB215		X				X					
BSB218		X		X							
BSB220	X	X		X						X	
BSB268		X		X							X
BSB612			X					X	X		
BSB615			X				X		X		
BSB618			X		X				X		